

HYDROQUIP™

Outdoor Series INSTALLATION MANUAL

THE **SMART CHOICE**™

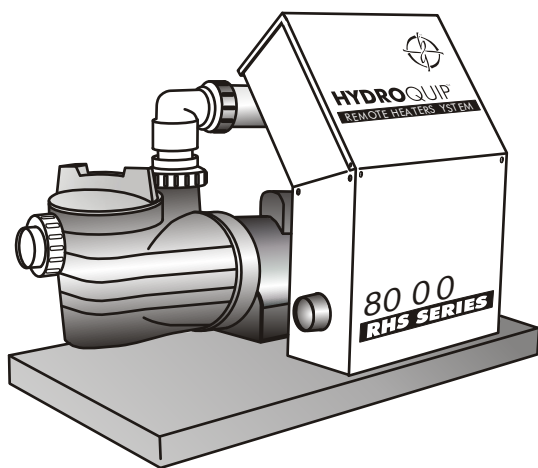

To ensure that the system is installed properly, provide your electrician with these instructions.

8600 Series

ELECTRICAL INSTALLATION

A qualified and licensed electrician in accordance with the National Electric Code (NEC) Article 680, Canadian Electric Code, and with any local codes must accomplish the electrical installation.

All connections must be made according to the electrical installation label on the outside of the control box (see page 12). Follow the instructions from the label if they are different than the instructions in this manual. If your electrician is not absolutely sure how to connect your system correctly, call your local dealer. Any mistake may be costly and invalidate your equipment warranty.

The GFCI (Ground Fault Circuit Interrupter) is a mandatory electrical safety device required for all portable spas and hot tubs as specified in the National Electrical Code Article 680-42. The GFCI in your particular installation may be installed at the electrical service panel, a separate sub-panel or built into your Hydro-Quip System.

Your spa equipment requires a DEDICATED CIRCUIT. No other appliances or lights can be on this circuit. Refer to equipment data label for power supply requirements of your spa equipment.

Use copper conductors ONLY. The ground must be sized following the National Electric Code, Table 250-95.

For Power conductor size, refer to the National Electric Code Table 310-16.

NOTE: Due to the electrical requirements of some models, it may be required to SPLIT the incoming electrical service to accommodate the GFCI Circuit Breaker limits. Contact your electrician if you need additional information on this topic.

	*							*
Circuit & Breaker Rating	15A	20A	30A	40A	50A	60A	70A	80A
Maximum Amps	12A	16A	24A	32A	40A	48A	56A	64A
Minimum Wire Size	14	12	10	8	6	4	4	4

Universal Systems require a Neutral wire therefore the service required is as follows: 120-volt systems require a three-wire electrical service including ground, consisting of Line 1 (Black), Neutral (White) and Ground (Green). 240-volt systems require a four wire electrical service including ground, consisting of Line 1 (Black), Line 2 (Red), Neutral (White) and Ground (Green).

***Split Load - See Page 3**

ELECTRICAL CONNECTIONS



IMPORTANT - The NEC and most local codes require that a “disconnect” be installed within “line-of-site” of the spa.

ELECTRICAL INSTALLATION DETAILS

Refer to the System Data Label for equipment voltage and maximum amperage draws.

Install proper size Ground Fault Circuit Interrupter (GFCI) or circuit breaker, then proper sized wiring and bonding wire. For Power conductor size, refer to the National Electric Code Table 310-16. For Ground conductor size, refer to the National Electric Code Table 250-122.

A bonding lug has been provided on the control box to allow connection to local ground points. To reduce the risk of electrical shock, a solid copper bonding wire should be connected from this lug to any metal ladders, water pipes or other metal object within 5 feet of the spa.

! WARNING - BE SURE THAT YOUR POWER SUPPLY CIRCUIT CAN ADEQUATELY HANDLE THE AMPERAGE YOU SELECT.

The control input power wiring may have been provided. Following NEC and local codes in effect at the time of installation, connect (refer to wiring diagram located on the inside of control hinged cover) the Black wire to input Line 1, Blue wire to input Line 2 (if applicable), White wire to Neutral and the Green wire to ground.

INSTALLATION CONSIDERATIONS

Hydro-Quip 8000 Series Solid-State Systems were designed for indoor or outdoor installations. This equipment may be used for in-ground as well as aboveground spas.

- *The Equipment System must be installed on a firm, level surface (example, concrete pad).*
- *Locate System as close to the spa as practical but no more than 25' away from it (**consult local codes for minimum distance between equipment and spa**).*
- *The area where the System is mounted must have adequate drainage to prevent flooding the equipment under all circumstances.*
- *Provide adequate access around and above the System for service and maintenance. Three feet (3') of clearance around the equipment is recommended.*
- *The pump(s) provided with the System may be self-priming or non self-priming. Non self-priming pump(s) must be installed below the normal spa water level.*
- *All components such as the pump(s) and air blower are connected using molded connectors located inside the component connection compartment (below the control box).*

ELECTRICAL CONNECTIONS

OPTION 1 GFCI Installed in Main Service Panel

20-60AMP
HARDWIRED

If the manufacturer of your homes main breaker panel makes a GFCI breaker, you may be able to add it to an open slot in the panel.

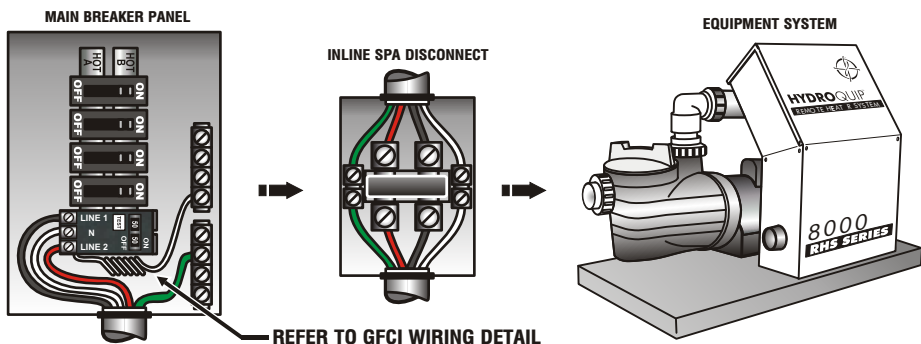

Power from GFCI breaker installed into main service panel to a service disconnect within line-of-site of the spa.

OPTION 1a Subpanel GFCI Installed

20-60AMP HARDWIRED

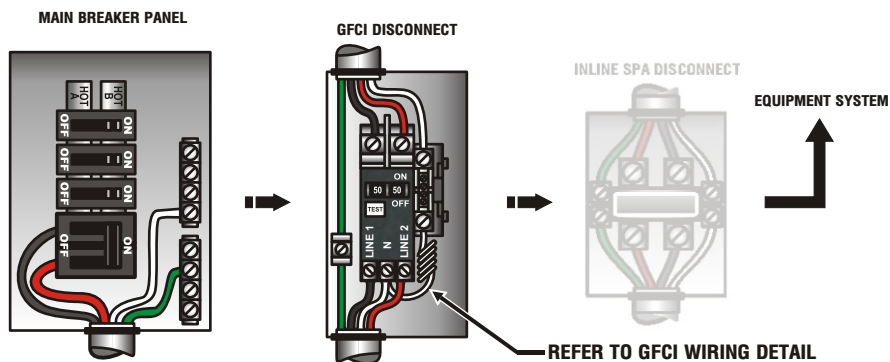

Power from main service panel to a GFCI subpanel within line-of-site of the spa. (Note: Most local codes will allow a GFCI subpanel to be a disconnect. If this is not the case in your installation, a disconnect must be provided.)

***Split Load is 2 each**

GFCI WIRING DETAIL

When a GFCI circuit breaker is used in the installation of your spa, it is important that it has been properly installed. Often this component has been improperly installed causing the breaker to trip the instant the system is turned on. Below is an illustration of a typical GFCI breaker installation.

WARNING: Refer to Circuit Breaker Manufacturers installation instructions. This illustration is meant to be a guide for Field Technicians and is not intended to override or substitute the instructions supplied with the circuit breaker.

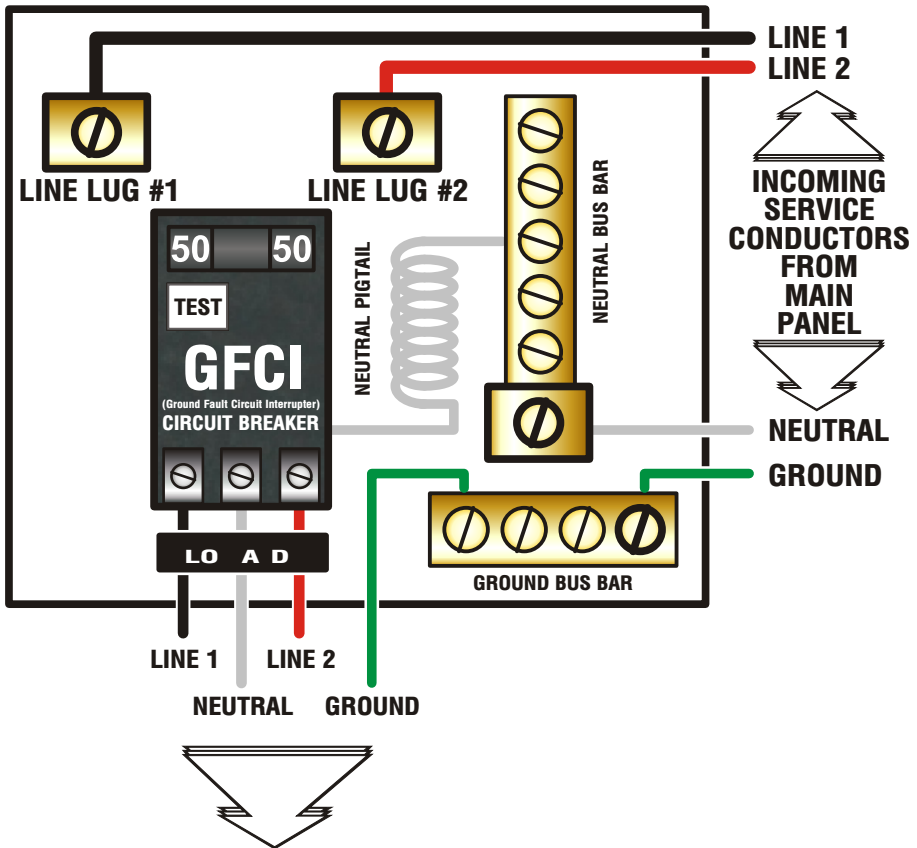

MAIN INPUT / HEATER INPUT SERVICE

LOAD NEUTRAL MUST BE CONNECTED DIRECTLY TO GFCI AS SHOWN

ELECTRICAL CONNECTIONS (Split)

Due to amperage requirements a split circuit connection may be required.

Pumps, blower, etc are isolated to the “Main Input Service” connections. This connection requires a L1, L2, Neutral, and Ground (See Illustration Below)

The heater connection is isolated to the “Heater Input Service” connection located on the **BACK OF THE PCB MOUNTING PLATE**. Remove the (2) upper screws on the sides of the upper box, the mounting plate will tilt forward allowing access to the connection points. This connection requires a L1, L2, and Ground connection. (See Illustration Below)

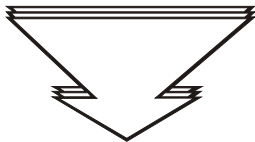
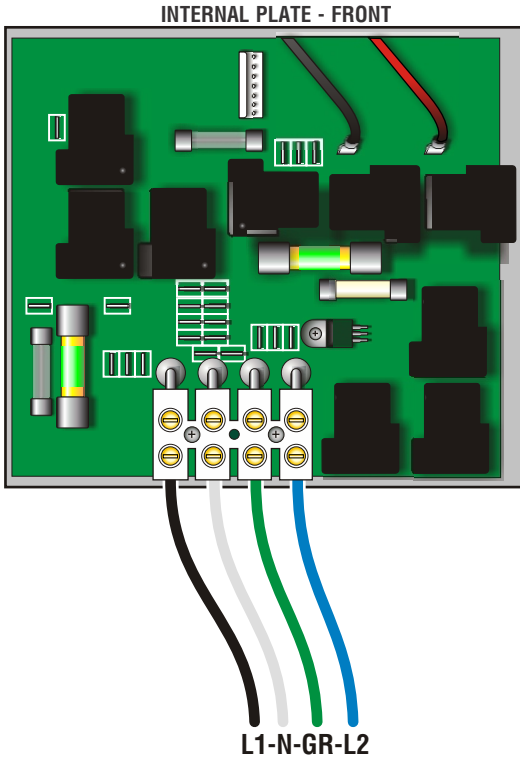

MAIN INPUT SERVICE

(CHECK PRODUCT DATA LABEL FOR AMPERAGE RATING)

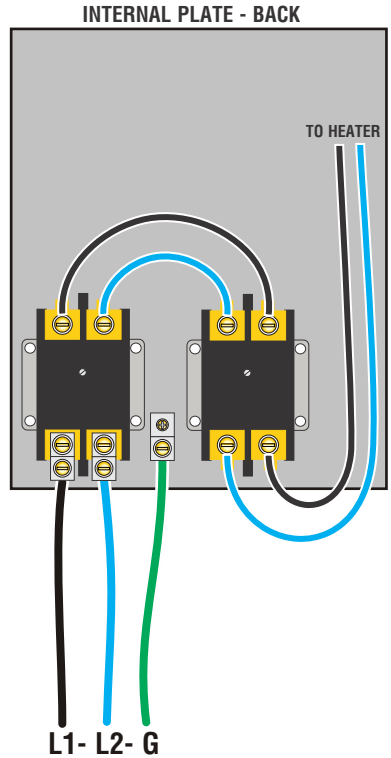

HEATER INPUT SERVICE

(CHECK PRODUCT DATA LABEL FOR AMPERAGE RATING)

ELECTRICAL CONNECTIONS (Single)



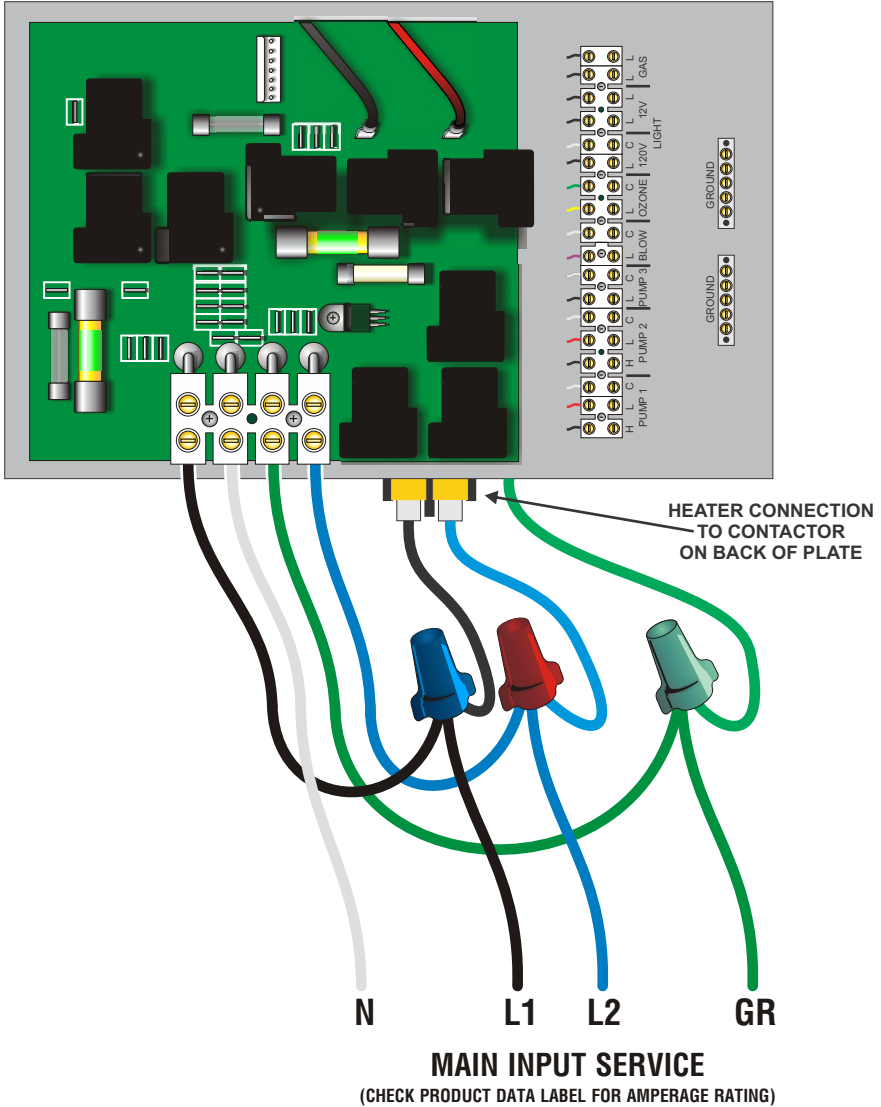

IMPORTANT - When a "split circuit" connection cannot be utilized due to retrofit or other issues, connect "single circuit" connection as shown below.



SYSTEM CONFIGURATION

The control circuits for components not included with the system have been pre-configured for 120V at the factory. This is to prevent accidental damage to equipment. A 240V component connected momentarily to a 120V power supply will not be damaged. A 120V component connected to a 240V power supply can be damaged immediately. For this reason Hydro-Quip cannot be held responsible for damage caused due mis-wire.

Below are illustrations and instructions for converting the universal circuits of your control. Hydro-Quip utilizes colored connectors to help identify each circuit. Simply locate the colored connector on the Neutral (white) wire from each components receptacle. Using the wiring diagram provided with each control (located inside the hinged cover), remove the Neutral connector from its 120V / Neutral position and reconnect to the 240V / Line 2 connection (shown in parenthesis on the wiring diagram). Once accomplished the conversion is complete. Repeat these steps as required for each 240V component.

<u>CIRCUIT</u>	<u>COLOR</u>	<u>CIRCUIT</u>	<u>COLOR</u>
PUMP 1	 RED	OZONE	 YELLOW
PUMP 2	 VIOLET	CIRC. PUMP	 BROWN
BLOWER	 BLUE		

(1) Remove connector from 120V connection

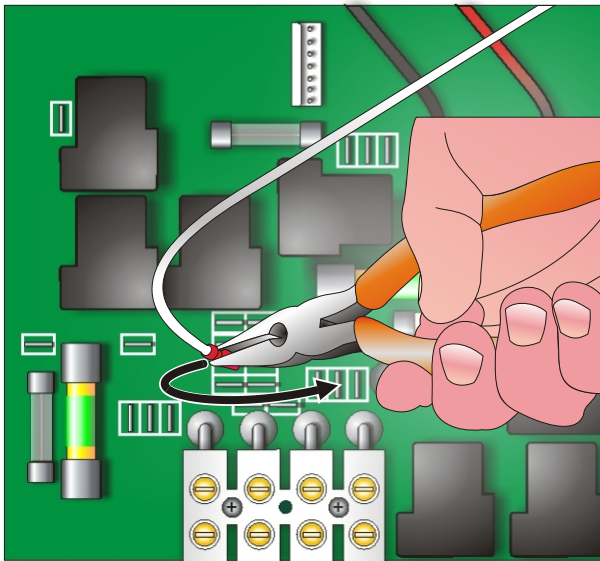

(2) Reinstall connector onto 240V connection

PUMP CORD INSTALLATION

The equipment system has been provided with a pump power cord and liquid-tight conduit assembly. This is to be used on the main 2-speed pump supplied with the system. Any other components or accessories attached to the equipment system should be attached in a similar manner.

Follow the simple instructions below to quickly attached the cord assy to the pump:

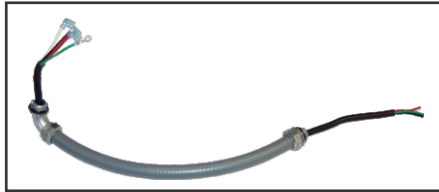

Cord Assy included for Pump 1

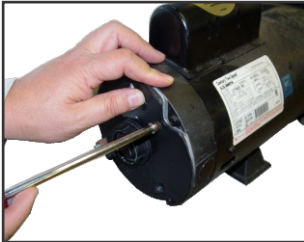

1) Remove the terminal cover off the back off the pump

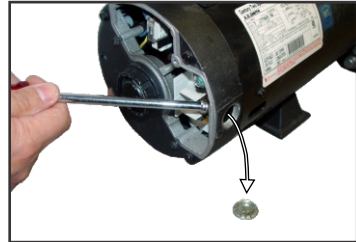

2) Remove the conduit hole cover

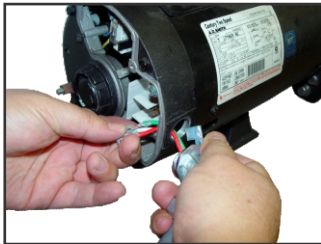

3) Route the power wires through the conduit hole and pull toward you to allow for the cord assy to be rotated for tightening.

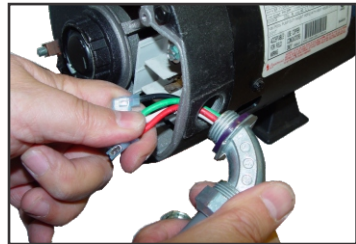

4) While holding the wires as shown thread the liquid-tight connector into the pump until secure then connect the power wires to the pump per the label on the pump.

WIRING NOTE:

RED = LOW
BLACK = HIGH
WHITE = COMMON
GREEN = GROUND



5) Route the other end of the conduit through and empty knock-out and secure with lock-nut. The cord inside will route up to the terminal strip inside the upper portion of the enclosure.

COMPONENT CONNECTION

The system is set up to have components hardwired to a terminal strip inside the upper enclosure. **Liquid tight conduit must be used on all externally added field connections exposed to the weather.** Route and connect the conduit to the knock-outs in the back of the lower box. The wires will then enter the bottom of the upper box through another set of knock-outs. Connect the component(s) accordingly to the corresponding position on the terminal strip and tighten securely. Refer to the included wiring diagram as needed. All components not included with the system are set at the factory for 120V. Verify the voltage of the additional component(s) and adjust supply voltage if necessary by referring to System Configuration on page #7.

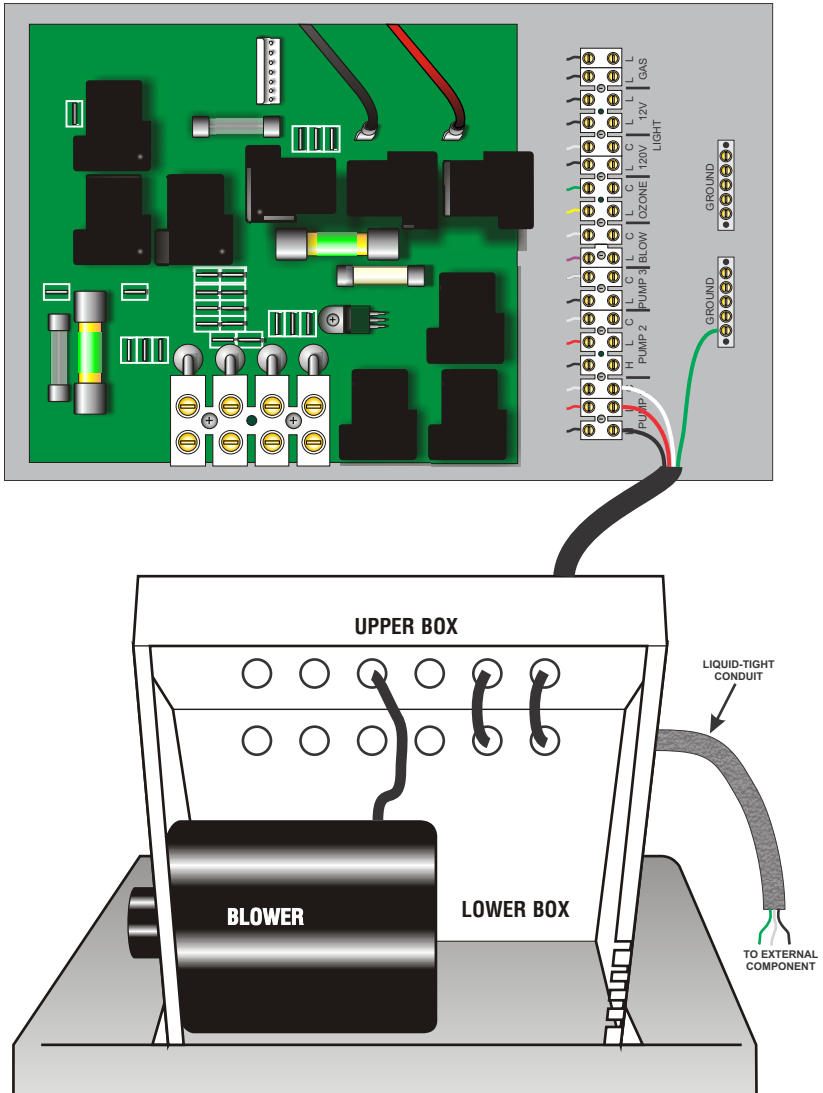

SPASIDE CONTROL INSTALLATION

First choose a location for the spaside control. Using the template provided, cut out a 2 5/8" X 6 3/8" hole.

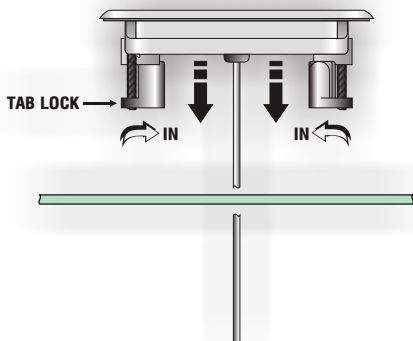

Step 1 - Clean area and insert spaside control (ensure tab locks are rotated inward).

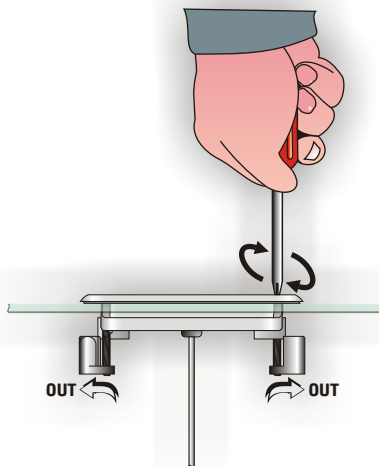

Step 2 - Rotate lock tab screws on face of control clockwise to engage locks and secure control into place.

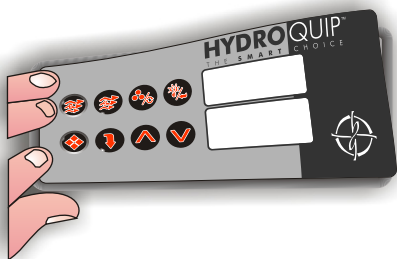

Step 3 - Remove protective film from display windows, clean control surface with rubbing alcohol and apply label.

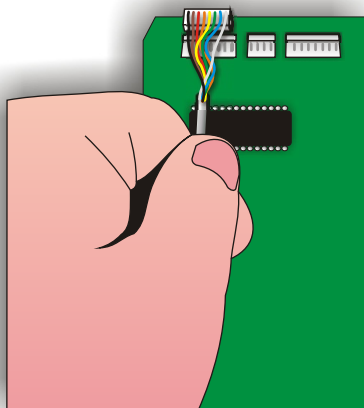

Step 4 - Connect spaside control plug to circuit board as shown.

DRYWELL INSTALLATION

If the existing placement of your temperature sensor does not allow for an accurate temperature reading a drywell may have to be installed in the spa wall. Once a location has been chosen, cut a 1 1/8" hole (cut from inside the spa). Clean excess debris from around the hole. Use a water resistant silicone applied to the sealing surfaces and insert the drywell into the hole. Tighten the drywell nut being (DO NOT over tighten). Insert temperature sensor into drywell and insert grommet as shown below. Allow silicone to cure for 24-hours.

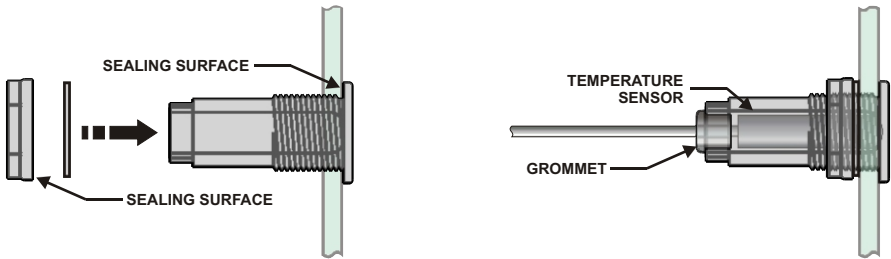

SPA LIGHT INSTALLATION

To offer the most flexibility, Hydro-Quip configures each 8000 Series system so that it can accept a 120-Volt or 12-Volt light. A separate connection terminal block has been provided (clearly marked) for this reason. Configure your light connection using the illustration below.

Using a suitable 2 1/2 " diameter hole-saw, cut a hole in the spa wall. Cut from inside the spa wall toward the outside to prevent splintering the inner surface. Remove any insulation material from around the hole (at least 1/2 ") at the outside spa wall. Install the gasket onto the light body and install the light into the hole. Take care not to over tighten the nut securing the light body. (Silicone sealant may be used in place of the gasket. Allow adequate time for sealant to cure before filling the spa.)

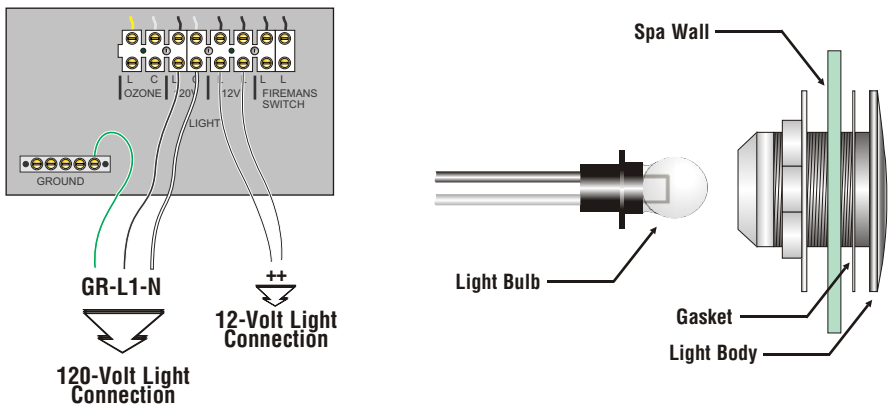

GAS HEATER CONNECTION

WARNING: Do not install a spa that utilizes a natural or propane gas heater indoors. These units require adequate ventilation and are not intended for indoor use. Install with non-metallic pipe fittings and connections at least 5-feet from all metal surfaces.

IMPORTANT - Be sure to read and follow all of the installation instructions provided by the heater manufacture. Follow these guidelines:

GAS HEATERS

A Fireman's Switch circuit has been provided, located in the upper enclosure.

The System should be connected in series with the gas heaters thermostat, flow or pressure switch circuit to control the heater. Set the remote heater thermostat to the highest setting. **All safety circuits remain intact on the remote heater.**

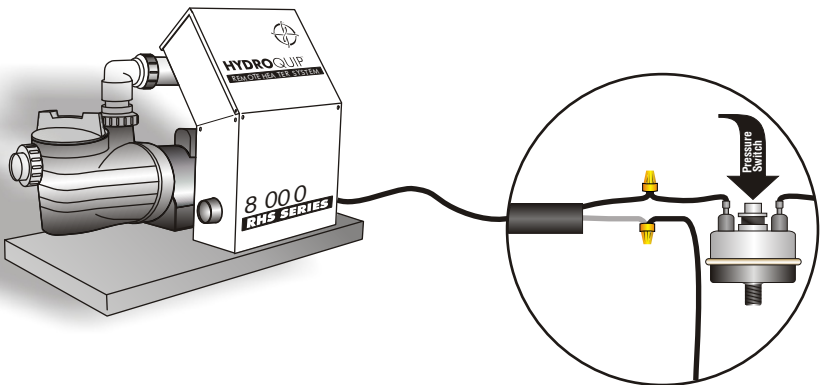
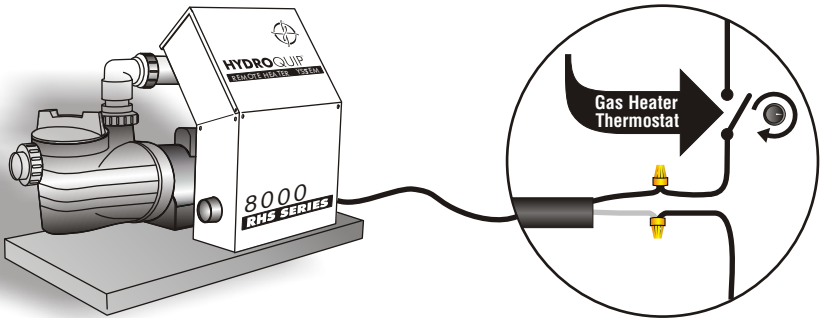

PSI/FLOW SWITCH OPTIONS

To cover unknown challenges that may be encountered during installation Hydro-Quip has integrated both a Pressure & Flow switch into the system. The system leaves the factory in the Standard configuration. Use the illustrations below to configure your system to meet your specific needs.

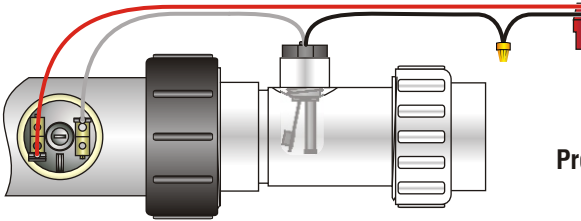

STANDARD
Pressure & Flow switch active

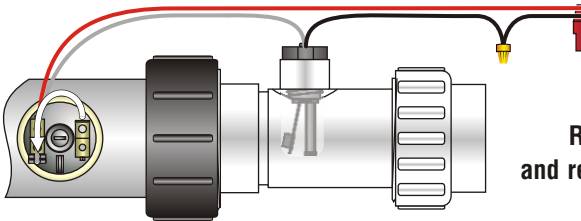

PSI BYPASS
Remove standard connector
and reinstall on piggyback connector
on Pressure switch.

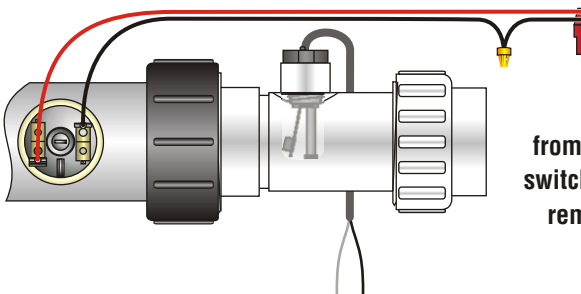

FLOW BYPASS
Remove Flow switch wire
from wire-nut. Cut remaining Flow
switch wire and splice together with
remaining wire to circuit board.

SPECIAL CONSIDERATIONS

If your system is equipped with a pressure switch, the function of the pressure switch is to turn the heater off if the pump stops operating or if there is a restricted water flow (dirty filter, obstruction in the spa plumbing etc.).

The pressure switch has been preset at the factory to operate properly with your spas specific plumbing. Adjustment or other service may be required if you observe a flow related problem (3 flashing dots on spaside display on solid-state product and/or non-operation of heater). If adjustment is required, follow the next steps carefully.

IMPORTANT: After any pressure switch adjustment, it is important to test the control by turning on the pump low speed and heater. While operating, unplug the pump, the heater must turn off. If the heater stays on, plug the pump back in and readjust the pressure switch to achieve proper operation.

Adjustment

- 1) *With power to system turned OFF, remove the wires from the pressure switch terminals (secure wires safely to prevent any chance of electrical shock).*
- 2) *Turn the thermostat counter-clockwise to the OFF position (use temperature adjustment key on solid-state systems to move "set point" temperature to its lowest setting).*
- 4) *Turn power to the system ON and activate the low-speed pump.*
- 3) *Place an Ohmmeter across the pressure switch terminals to verify an OPEN circuit.*
- 4) *Rotate the pressure switch adjustment screw counter-clockwise until the Ohmmeter indicates a CLOSED circuit.*
- 5) *Turn pump OFF and verify that the pressure switch circuit is once again OPEN.*
- 6) *Turn power to the system OFF and reconnect pressure switch wires. Reapply power to the system and operate the spa or hot tub as normal.*

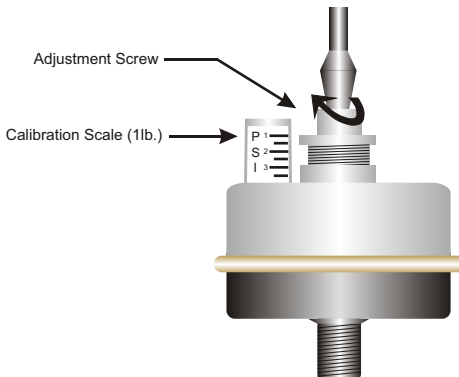

SYSTEM STARTUP

System Startup Procedures:

Using the “System Operation Manual” provided with the unit, complete the following procedures:

- 1) Read and familiarize yourself with the system Operation manual.
- 2) Unplug the power cord (120-volt system only) or turn the electrical power “OFF” at the service or breaker panel (120 or 240 volt permanently connected units.)
- 3) Open all **WATER** shut-off valves.
- 4) For spas equipped with a hose bib or drain valve, make sure that it has been closed.
- 5) For spas equipped with in-line or pressure water filters, make sure that the filter nut, housing drain plug, and air relief valve are closed and tight.
- 6) Using a standard water hose, fill the spa with fresh tap water to the level recommended by the spa manufacturer.
- 7) Inspect all plumbing connections and lines for any sign of water leaks.
- 8) Close all **AIR** control valves. **WARNING:** Do not confuse with **WATER** shut-off valves.
- 9) Adjust temperature to the lowest setting. **Note: if your system includes a “Mode Selector Switch”, set to program mode 2.**
- 10) Plug the unit into the proper outlet (120-volt system) or turn on the breaker at the electrical service panel (240-volt system).
- 11) On units with a Ground Fault Circuit Interrupter (GFCI), check the GFCI by pressing the “Test” button on the face of the device. The “Reset” button should pop out. **The equipment should not operate.**
- 12) Activate the equipment by pressing the “Reset” button on the GFCI. (If the jet pump(s) or blower is operating, switch them off).
- 13) Press the “JET PUMP” switch to run on high speed. Allow to run until you achieve a strong, steady water flow (free of air bubbles).
- 14) On systems with a pressure filter, bleed off the trapped air by opening the Air-Relief valve. You will notice a steady flow of water when the air has been bled completely.
- 15) Switch the “JET PUMP” off.
- 16) If equipped, switch the “AIR BLOWER” on to verify that it is working, then switch it off.
- 17) If equipped, switch the “LIGHT” on to verify that it is working, then switch it off.
- 18) If equipped, switch the “AUXILIARY PUMP” on to verify that it is working, allow to run until all air is evacuated from the plumbing system, then switch it off.
- 19) Adjust temperature to the desired set point for comfortable use of the spa. The pump low speed and heater will activate until the set point has been reached.

It is now time to turn over operation of the spa to the homeowner. See next section for basic troubleshooting tips.

TROUBLESHOOTING

The following describes situations and possible solutions to common problems may encounter as a spa owner. **Note: your system may not include all components listed.**

NOTHING OPERATES

Main Breaker is OFF - Set to On.
Sub-Panel Breaker Off - Set to On.
System GFCI Off - Set to On.
Power switch in Off position - Set to On.
Components not plugged in - Plug in components.
Power cord not plugged in - Plug in power cord.

NO, LOW OR SURGING WATER FLOW

Air Lock in Plumbing System - "Bleed" the system.
Restricted Flow - Insure that the water shut-off valves are open and that suction fittings are not blocked by debris.
Low Water Level - Increase water level to recommended level.

NO LOW SPEED PUMP OPERATION

Pump 1 Not Plugged-In - Plug in Pump 1.
Pump 1 Fuse Blown - Contact you local dealer.
Pump 2 Not Plugged-In - Plug in Pump 2.
Pump 2 Fuse Blown - Contact you local dealer.

NO JETS OR BLOWER OPERATION

Blower or Pump Not Plugged-In - Plug in the Blower or Pump.
Pump or Blower Fuse Blown - Contact you local dealer.

NO THERAPY JET OPERATION

Water Shut-Off Valves are Closed - *Open Shut-Off valves.*

Jets Not Properly Adjusted - *Adjust Jets properly.*

Diverter Valve Not Properly Adjusted - *Adjust diverter valve properly.*

Thermal Overload Tripping - *Check for restricted flow of water.*

NO LIGHT OPERATION

Light Bulb Defective - *Replace bulb or contact your local dealer.*

Reflector has Fallen Off - *Replace deflector or contact your local dealer.*

Light Not Plugged-In - *Plug in the Light.*

WATER LEAKS

Spa Overfilled - *Adjust water level.*

Drain-Valve Left Open - *Close drain valve.*

Couplings or Unions Loose - *Tighten or contact your local dealer.*

Pump Seal Leaking - *Contact your local dealer.*

Plumbing / Connections Leaking - *Contact your local dealer.*

Water Leaking from Spaside Control - *Contact your local dealer.*

Water in Air Blower Plumbing - *Contact your local dealer.*

NO HEAT

Temperature Not Set Correctly - *Adjust "Set Point" Temperature.*

System Power Restriction - *Depending on available power, the spa may have interlocks in place to shut off the heater when the pumps are switched to high speed.*

HIGH HEAT

Temperature Sensor Not in Dry-Well - *Place sensor in dry-well.*

Temperature Set Too High - *Adjust "Set Point" Temperature.*

High Ambient Temperature - *Remove spa cover.*

GFCI TRIPS IMMEDIATELY

For correct GFCI breaker wiring, refer to page 4 for details.

SYSTEM DATA LABEL

The system data label is located on the control box. This label is very important and contains information you will need to establish your electrical service. The voltage and amperage ratings are shown on the bottom of the label. Product, Model, Serial and Code numbers are also shown on the label.

Note: *This information will be necessary if you should ever have to request warranty or any other type of service.*



HYDROQUIP™
THE **SMART** CHOICE™

ORDER CODE: _____

MODEL: _____

SERIAL: _____

CODE: _____

VOLTS: _____

AMPS: _____

PRODUCT: _____

REFER TO NEC FOR
BREAKER SIZING

EXTREME WEATHER CONDITIONS

For extremely "Hot" or "Cold" climates, the temperature and high-limit sensor should be located per the layout below. The temperature sensor can be installed either below grade in the suction plumbing or in a sensing well installed within the spa. The high-limit sensor may remain in its factory-installed location for "Cold" climates (below 35°F) but must be installed below grade when the equipment will be subjected to high temperatures (above 95°F).

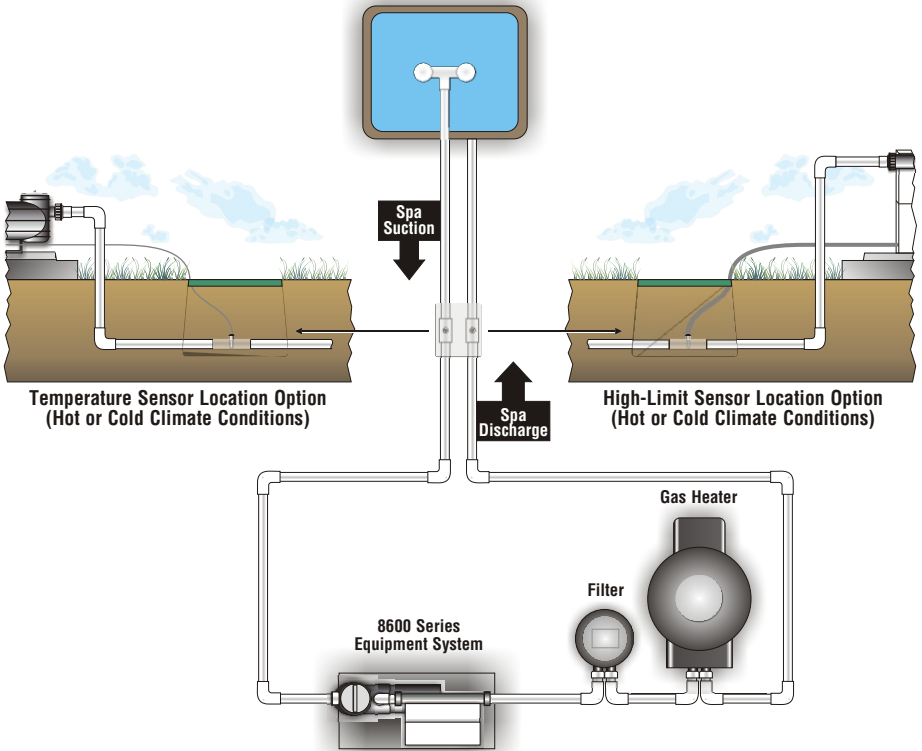

TYPICAL LAYOUT

(Note: All components above may not be part of your particular layout.)



HYDROQUIPTM

510A N. Sheridan Street · Corona, CA 92880-2024

Email: info@hydroquip.com · Internet: <http://www.hydroquip.com/>

Telephone: 951.273.7575 · Fax: 800.332.7190